

-40 V

-9 A

HTD350C04 TO-252 TD350C04

### Absolute Maximum Ratings at $T_j$

	N-CH	P-CH	Unit
$I_D$	8	-9	A
V			
V			
$I_{DM}$			

**J**

			Value			Unit
			min		max	
	V	$V_{GS} = 0V, I_D = 250\mu A$	40	-	-	V
	V	$V_{GS} = V_{DS}, I_D = 250\mu A$				
	I	$V_{GS} = 0V, V_{DS} = 32V, T_j$	-	-	1	$\mu A$
		$V_{GS} = 0V, V_{DS} = 30V, T_j$	-	-	25	
	I	$V_{GS} = \pm 20V, V_{DS} = 0V$	-	-	$\pm 100$	nA
	R	$V_{GS} = 10V, I_D = 10A$	-	30	35	m $\Omega$
		$V_{GS} = 7V, I_D = 8A$	-	40	50	
	g	$V_{GS} = 5V, I_D = 10A$	-	19	-	

	$C_{iss}$	$V_{GS} = 0V, V_{DS}$	-	515	-	
	$C_{oss}$		-	77	-	
	C		-	53	-	
	$Q_g$	$V_{DD} = 20V, I_D = 15A, V_{GS} = 10V$	-		-	nC
	$Q_{gs}$		-		-	
	Q		-		-	
Rise time	t	$V_{DD} = 10V, I_D = 1A, V_{GS} = 10V,$ $R_G = 6\Omega,$	-		-	ns
	t		-	12	-	
	t		-	4	-	

	V	$V_{GS} = 0V, I = 12A$	-			V
--	---	------------------------	---	--	--	---

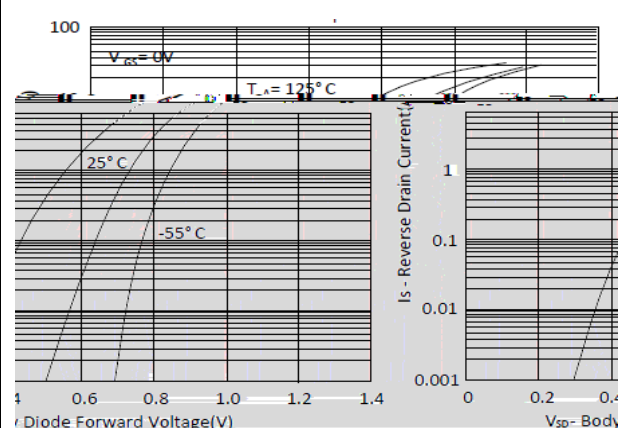
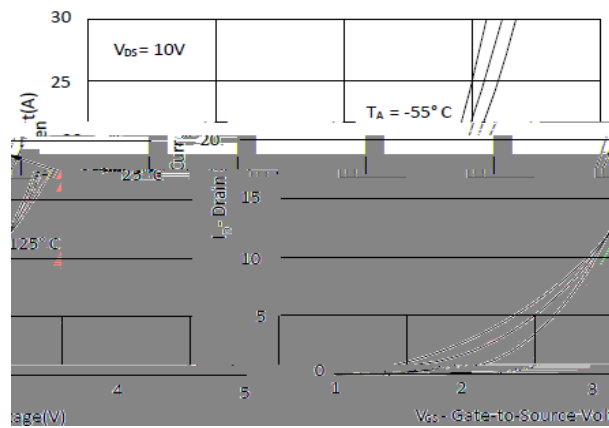
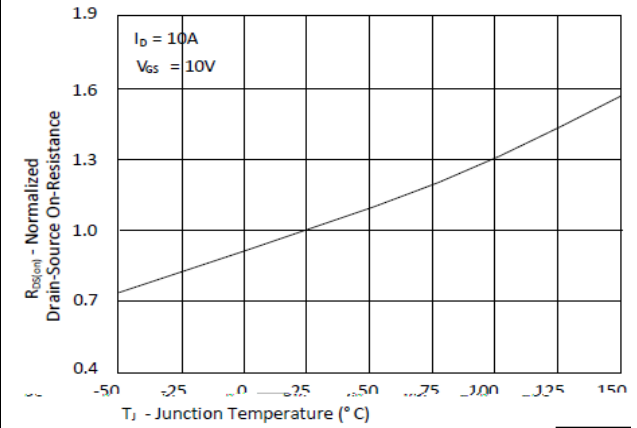
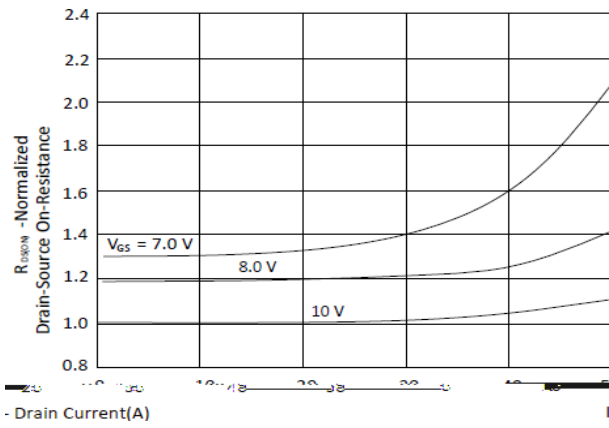
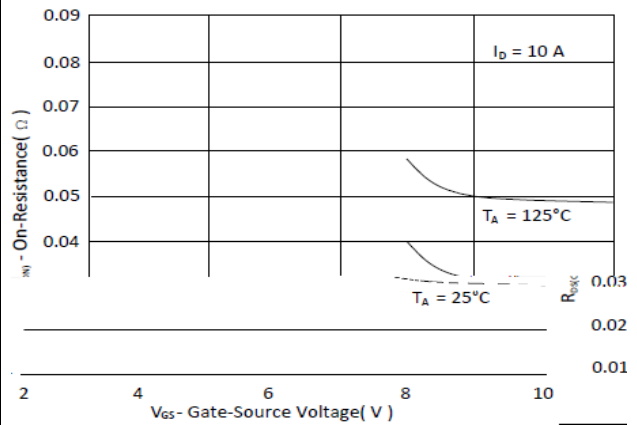
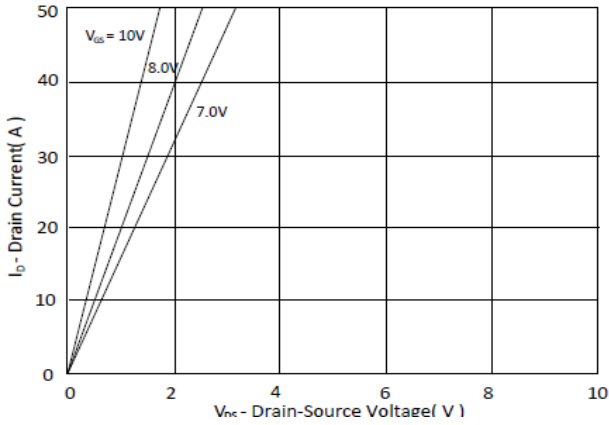

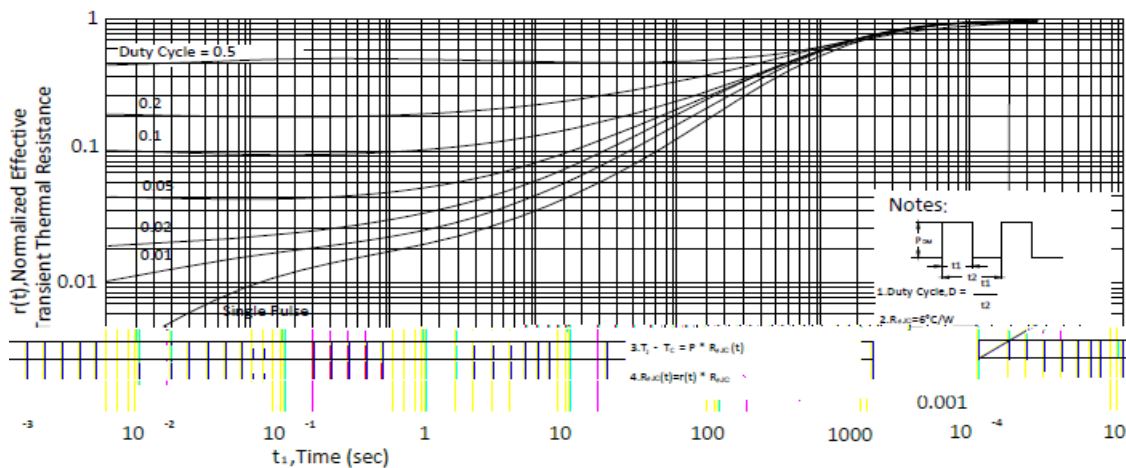
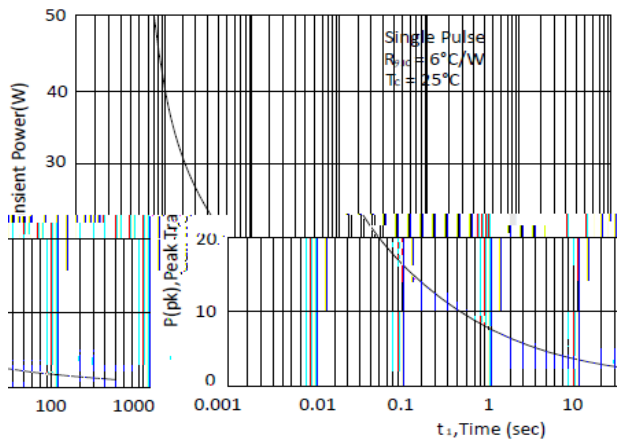
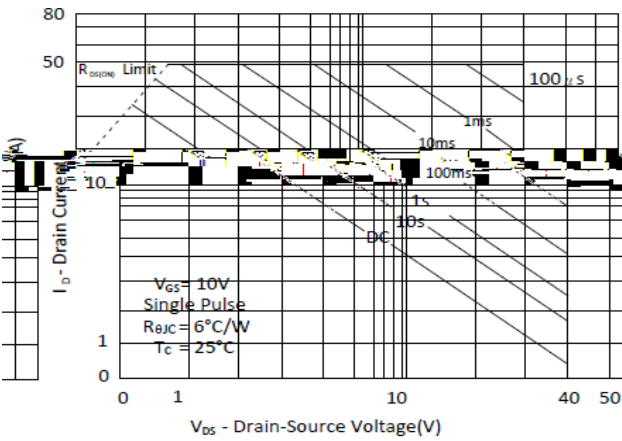
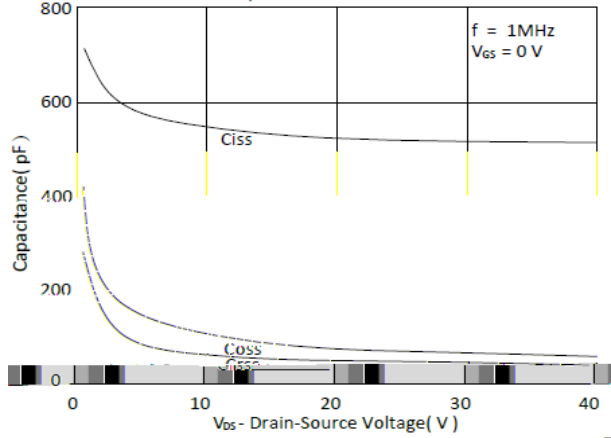
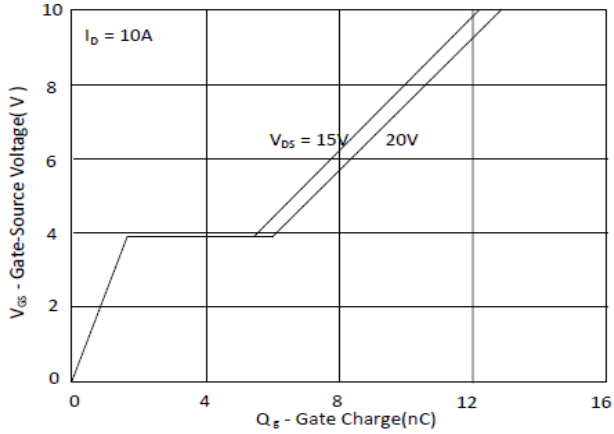

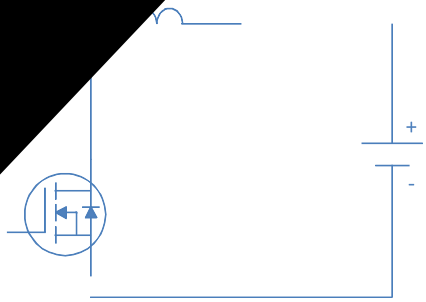
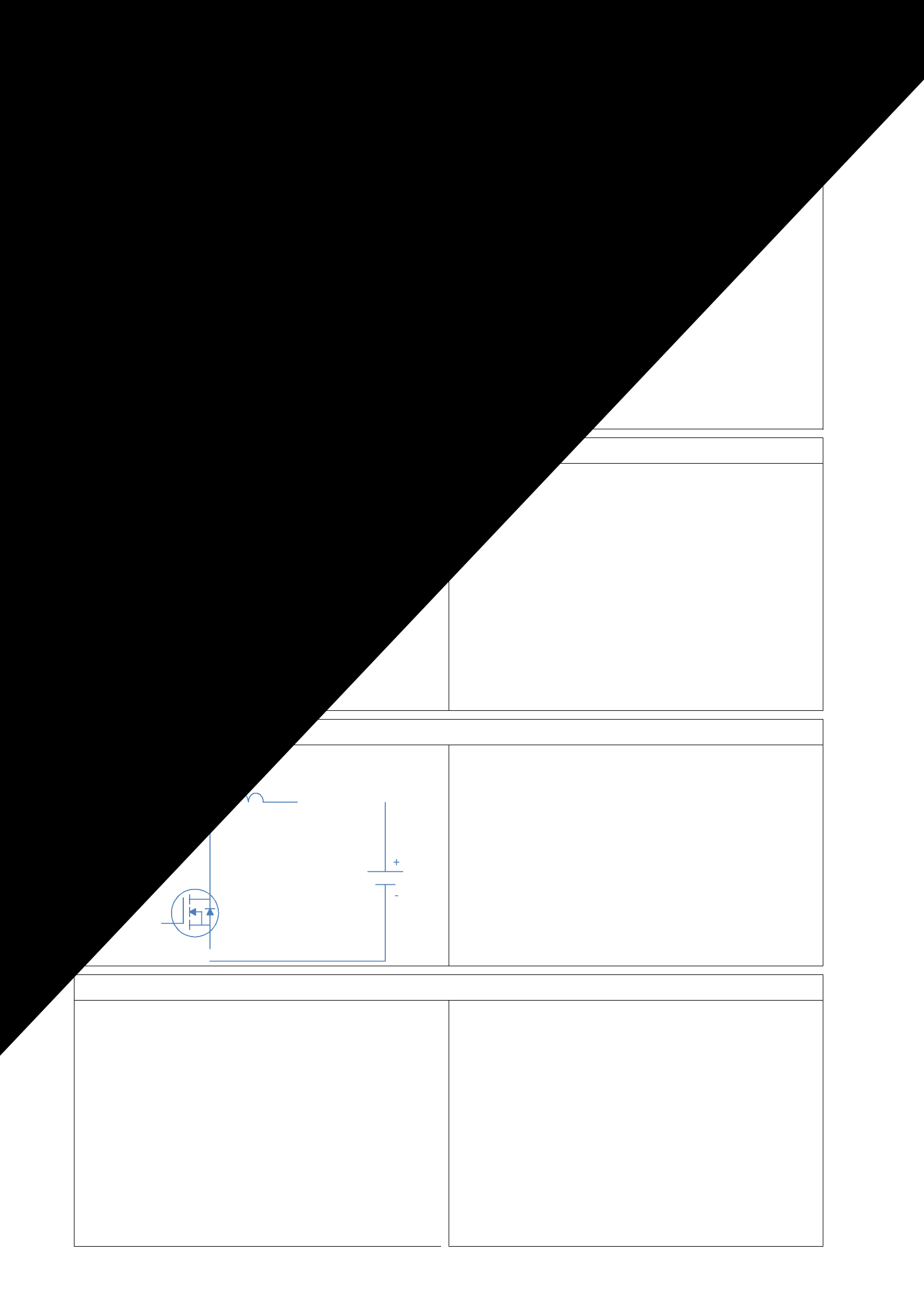

J

			Value			Unit
			min		max	
	V	$V_{GS} = 0V, I_D = 250\mu A$	-40	-	-	V
	V	$V_{GS} = V_{DS}, I_D = 250\mu A$				
	I	$V_{GS} = 0V, V_{DS} = -32V, T_J$	-	-	-1	$\mu A$
		$V_{GS} = 0V, V_{DS} = -30V, T_J$	-	-	-25	
	I	$V_{GS} = \pm 20V, V_{DS} = 0V$	-	-	$\pm 100$	nA
	R	$V_{GS} = -10V, I_D = -8A$	-	38	44	m $\Omega$
		$V_{GS} = -7V, I_D = -6A$	-	50	70	
	g	$V_{GS} = -5V, I_D = -8A$	-	11	-	

	$C_{iss}$	$V_{GS} = 0V, V_{DS}$	-	745	-	
	$C_{oss}$		-	78	-	
	C		-	58	-	
	$Q_g$	$V_{DD} = -20V, I_D = -10A, V_{GS} = -10V$	-		-	nC
	$Q_{gs}$		-		-	
	Q		-		-	
Rise time	t	$V_{DD} = -10V, I_D = -1A, V_{GS} = -10V, R_G = 6\Omega,$	-	7	-	ns
	t		-	10	-	
	t		-	20	-	
	t		-	12	-	

	V	$V_{GS} = 0V, I_D = -12A$	-			V
--	---	---------------------------	---	--	--	---

